

# VLP



Multi-channel open impeller with Vulkollan coating

All product images are indicative only

## General characteristics

Multi-channel open impeller with Vulkollan coating

motor power	1,5 ÷ 16,4 kW
poles	2 / 4
discharge	DN 50 - DN 80 horizontal
free passage	max 54 mm
max flow rate	49.7 l/s
max head	30.7 m

## Electromechanical assembly

Electromechanical assembly in GJL-250 cast iron, for submerged operation. Seal set comprising 2 (two) silicon carbide mechanical seals installed in series in inspectable oil sump and 1 (one) opposed graphite-alumina lip seal lubricated by the motor oil. Oil bath motor.

## Applications

The special coating on the impeller and hydraulic unit makes this electric pump ideal for transferring ceramic glazes or pumping very dense, strongly abrasive liquids.

## Construction materials

Case	Cast iron EN-GJL 250
Impeller	Cast iron with Vulkollan coating
Nuts and bolts	Stainless steel - Class A2-70
Standard gasket	Rubber - NBR
Shaft	Stainless steel - AISI 420
Cooling jacket	Carbon steel or stainless steel AISI 304
Paint type	Ecological bicomponent epoxy (medium thickness 150 µm)
Set of standard mechanical seals	Two silicon carbide mechanical seals (SiC) and one carbon-aluminium oxide mechanical seal (AL)

## Operating limits

Maximum operating temperature	40 °C
PH of treated fluid	6 ÷ 11
Viscosity of treated fluid	1 mm <sup>2</sup> /s
Maximum immersion depth	20 m
Density of treated fluid	1 Kg/dm <sup>3</sup>
Maximum acoustic pressure	70 dB
max starts per hour	20



**Cooling system**

The cooling liquid from an external circuit enters the cavity between the body and the jacket between an inlet hole to cool the motor. Once the cavity is full, the liquid flows down the special pipe into the mechanical seal sump, lubricating them before being expelled through the outlet hole.



**Structure**

Constructed in GJL-250 cast iron

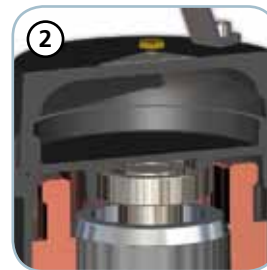

**Bearings**

Shielded ball bearings with lifetime lubrication

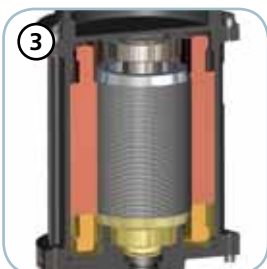

**Motor**

Oil-bath motor with thermal protections



**Mechanical seals**

Two mechanical seals in silicon carbide (SiC) and one mechanical seal in alumina graphite (AL)



**Oil sump**

Large oil sump to guarantee longer mechanical seal lifetime



**Pump body**

Impeller and pump body in GJL-250 cast iron coated with abrasion-resistant polyurethane (Vulkollan)

# VLP

## Models with horizontal DN50 PN10-16 flanged discharge - 2 poles

### Performances

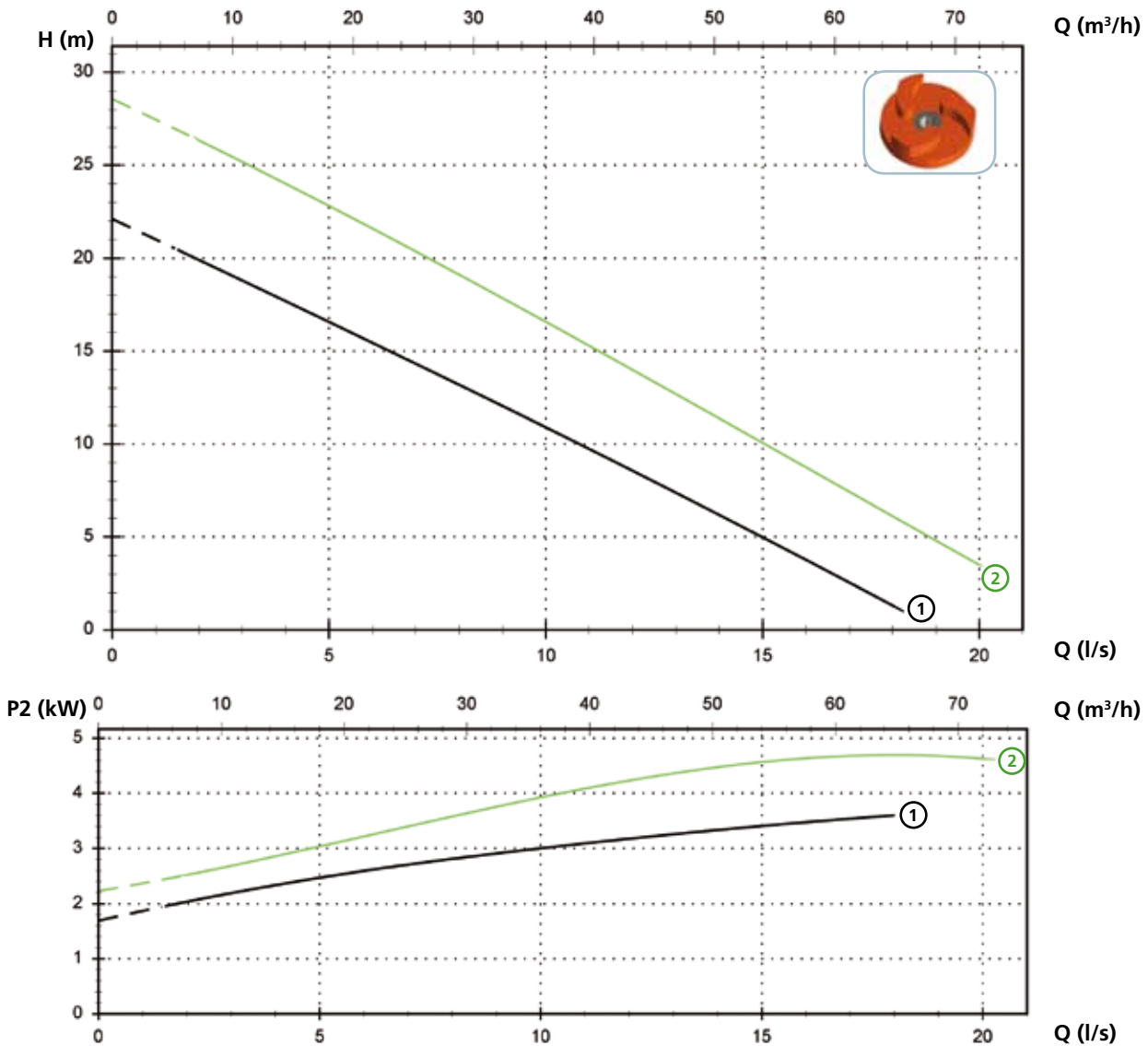

### Technical data

	V	Phases	P1 (kW)	P2 (kW)	A	Rpm	Start	Ø	Cable (*)	Free passage
① VLP 400/2/50 A0FT/50	400	3	4.7	3.6	8	2900	Dir	DN50 PN10-16	A	25 mm
② VLP 550/2/50 A0GT/50	400	3	5.9	4.9	10.1	2900	Dir	DN50 PN10-16	B	25 mm

(\*) A = H07RN-F 4G1.5 + H07RN-F 2G1 - 10 m  
 B = 07RN-F 4G2.5+3x1 - 10 m

Electrical and mechanical features are equal to the cable H07RN-F

Models with horizontal DN50 PN10-16 flanged discharge - 4 poles

Performances

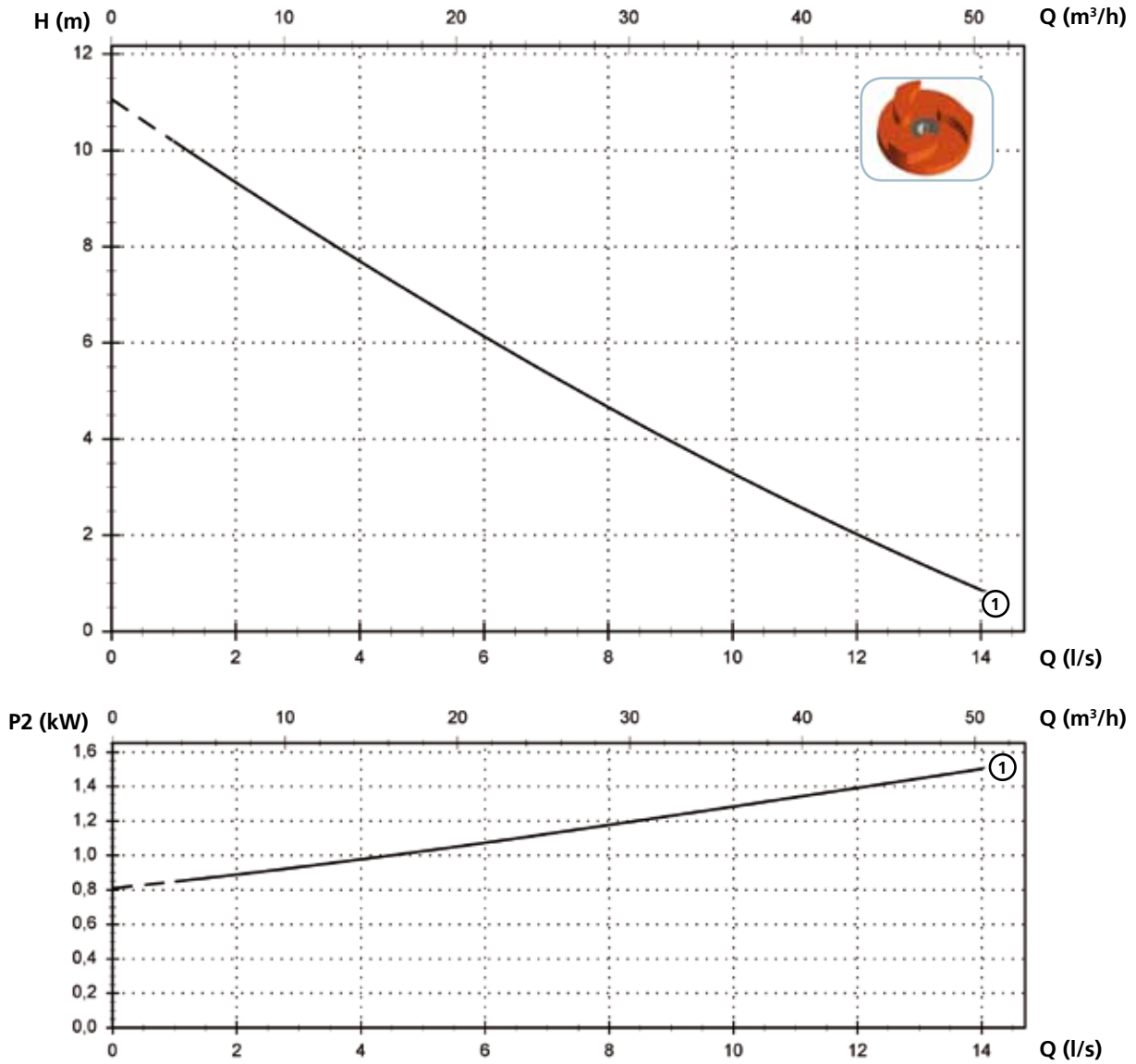

Technical data

	V	Phases	P1 (kW)	P2 (kW)	A	Rpm	Start	Ø	Cable (*)	Free passage	
①	VLP 200/4/50 A0ET/50	400	3	2.1	1.5	4.1	1450	Dir	DN50 PN10-16	A	28 mm

(\*) A = H07RN-F 4G1.5 + H07RN-F 2G1 - 10 m

# VLP

## Models with horizontal DN80 PN10 flanged discharge - 4 poles

### Performances

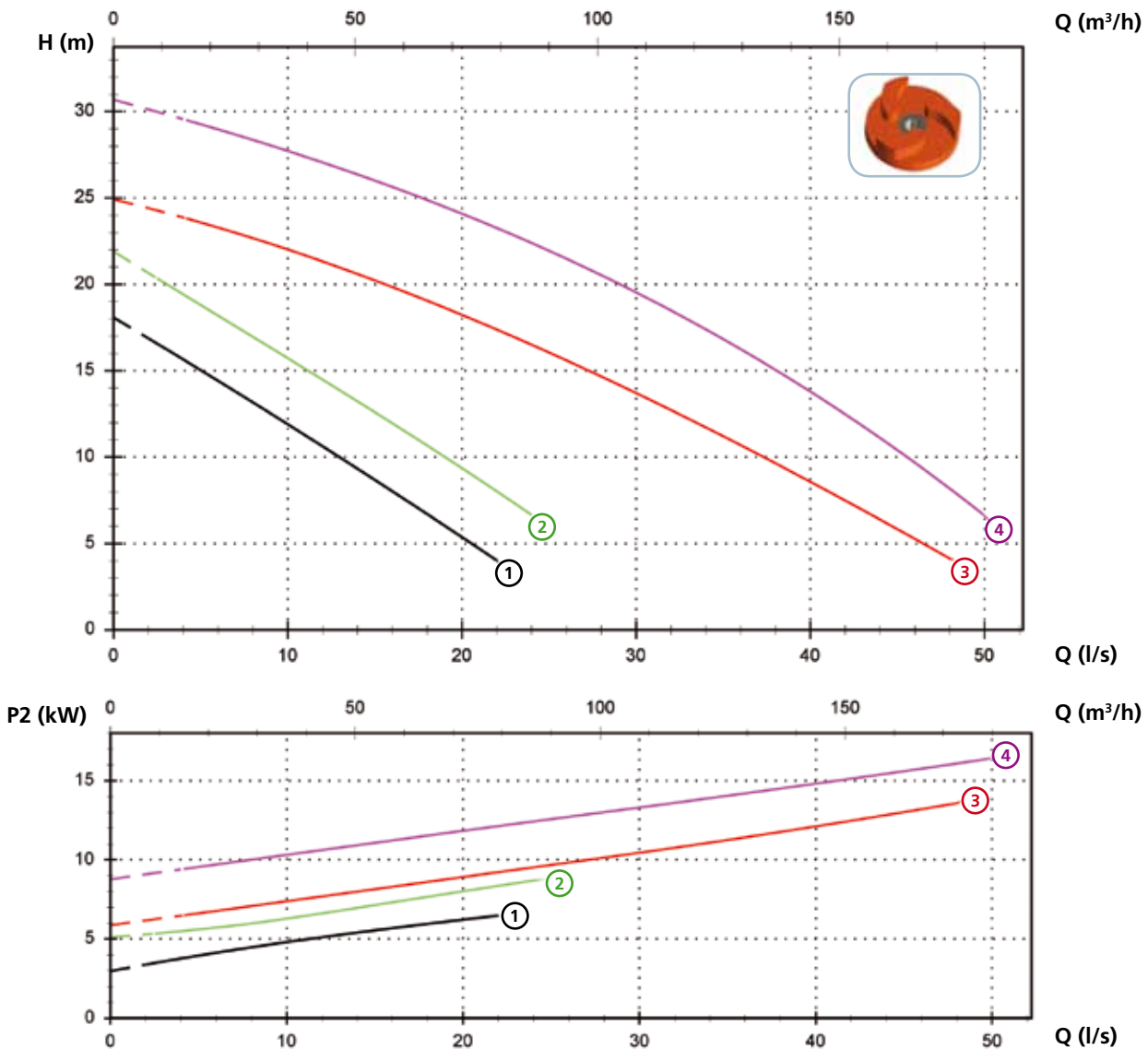

### Technical data

	V	Phases	P1 (kW)	P2 (kW)	A	Rpm	Start	Ø	Cable (*)	Free passage
① VLP 750/4/80 A0HT/50	400	3	8.6	6.5	14.9	1450	Y Δ	DN80 PN10	A	45 mm
② VLP 1000/4/80 A0HT/50	400	3	11.5	8.9	20	1450	Y Δ	DN80 PN10	A	45 mm
③ VLP 1500/4/80 A0IT/50	400	3	15.8	13.6	28.2	1450	Y Δ	DN80 PN10	B	54 mm
④ VLP 2000/4/80 A0IT/50	400	3	20.7	16.4	36	1450	Y Δ	DN80 PN10	B	54 mm

(\*) A = 07RN-F 7G1.5+3x0.75 - 10 m  
 B = H07RN-F 4G6 + H07RN-F 4G6 + H07RN-F 2G1 - 10 m

Electrical and mechanical features are equal to the cable H07RN-F

**Versions available**

(Key to versions on page 16)

	Electrical variants											Cooling				Mechanical seals				
	N A E	T	T C	T C D	T C D T	T C D G T	T C G	T C S T	T C S G T	T S	T R	T R G	N	CC CCE	F T	C G F T	2SIC	SICM	SICAL	2SICAL
VLP 400/2/50 A0FT/50		●										●		●	●					●
VLP 550/2/50 A0GT/50		●										●		●	●					●
VLP 200/4/50 A0ET/50		●										●		●	●					●
VLP 750/4/80 A0HT/50		●										●		●	●					●
VLP 1000/4/80 A0HT/50		●										●		●	●					●
VLP 1500/4/80 A0IT/50		●										●		●	●					●
VLP 2000/4/80 A0IT/50		●										●		●	●					●

**Overall dimensions and weights**

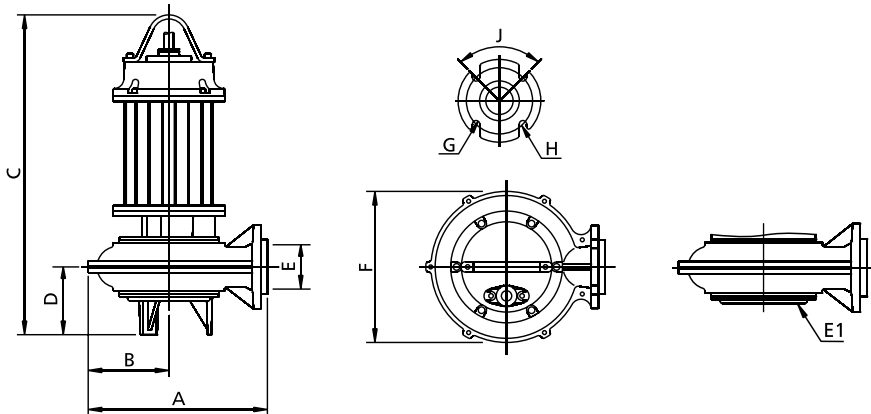

	A	B	C	D	E	E1(*)	F	G	H	J	kg
VLP 400/2/50 A0FT/50	290	140	555	105	50	-	260	18	125	90°	48
VLP 550/2/50 A0GT/50	290	140	655	105	50	-	260	18	125	90°	67
VLP 200/4/50 A0ET/50	290	140	555	105	50	-	260	18	125	90°	26
VLP 750/4/80 A0HT/50	435	195	775	165	80	DN150 PN10	365	18	160	90°	80
VLP 1000/4/80 A0HT/50	435	195	775	165	80	DN100 PN10	365	18	160	90°	81
VLP 1500/4/80 A0IT/50	490	235	970	175	80	-	440	18	160	90°	172
VLP 2000/4/80 A0IT/50	490	233	970	175	80	-	440	18	160	90°	190

Dimensions in mm

(\*) Suction flange available upon request

All weights and dimensions are indicative only

**Packaging dimension**

	A	B	C
VLP 400/2/50 A0FT/50	725	445	415
VLP 550/2/50 A0GT/50	725	445	415
VLP 200/4/50 A0ET/50	725	445	415
VLP 750/4/80 A0HT/50	915	515	555
VLP 1000/4/80 A0HT/50	915	515	555
VLP 1500/4/80 A0IT/50	915	515	555
VLP 2000/4/80 A0IT/50	915	515	555

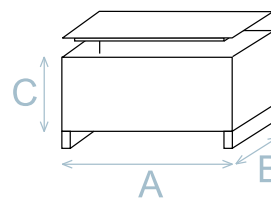

Dimension in mm

All weights and dimensions are indicative only

# VLP

## Installations available

